

Replacement Parts

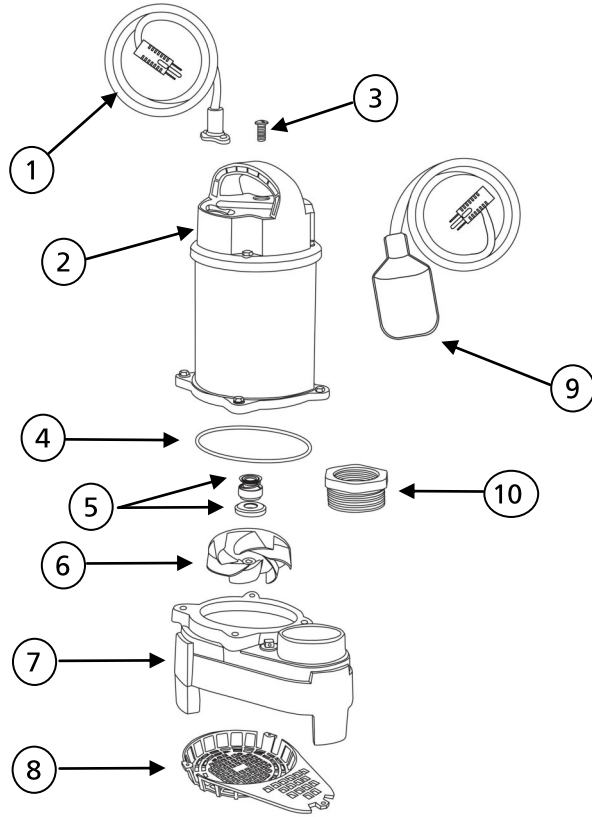

Ref#	Description	Part #
1	Power Cord	Please call your Professional Plumber for price and availability.
2	Pump Housing Cover	
3	Oil Fill Screw	
4	O-Ring	
5	Shaft Seal	
6	Stainless Steel Vortex Impeller	
7	Base / Volute	
8	Intake Screen	
9	Tethered Float Switch	
10	2" MNPT x 1-1/2" FNPT Adapter	

*If motor fails, replace entire pump



INSTALLATION & OPERATION MANUAL

SUBMERSIBLE EFFLUENT HIGH HEAD PUMPS

Models:

5040CUEFH25

5040CTEFH25

5050CUEFH25

5050CTEFH25

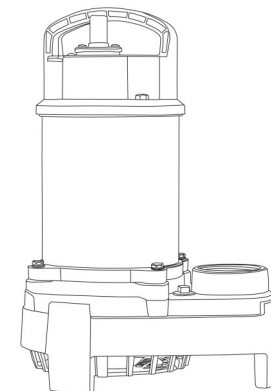

Non-Potable Use Only





www.aymcdonald.com

Safety Guidelines

Carefully read, understand and follow all safety instructions in this manual.

 This is the safety alert symbol. When you see this symbol, look for one of the following signal words.

 **DANGER** Indicates a hazardous situation which, if not avoided, will result in death or serious injury.

 **CAUTION** Indicates a hazardous situation which, if not avoided, could result in death or serious injury.

 **WARNING** Indicates a hazardous situation which, if not avoided, could result in minor or moderate injury.

Safety Information

Read these warnings carefully. Know the application and limitations of this pump. Failure to follow these warnings could result in serious bodily injury and/or property damage.

 **DANGER** RISK OF ELECTRICAL SHOCK. Disconnect and lockout power supply before removing old pump or installing or servicing this pump.

 **DANGER** RISK OF ELECTRICAL SHOCK. This pump is supplied with a grounding conductor and grounding type attachment plug. To reduce the risk of electric shock, be certain that it is connected only to a properly grounded, grounding type receptacle. For added safety, it is highly recommended to connect this pump to a GFCI (Ground Fault Circuit Interrupter) outlet.

 **WARNING** The installation of this pump must be in accordance with the National Electric Code (NEC), Uniform Plumbing Code (UPC), International Plumbing Code (IPC) as well as all applicable local codes and ordinances.

 **CAUTION** Do not install this pump in any location classified as hazardous by the National Electrical Code, ANSI/NFPA70.

 **CAUTION** Do not use this pump to pump flammable or explosive fluids such as gasoline, kerosene, etc. Do not use this pump in flammable or explosive environments. Use only with liquids compatible with pump component materials.

 **WARNING** RISK OF ELECTRICAL SHOCK. This pump has not been investigated for use in swimming pool or marine areas.

 **WARNING** Effluent pumps handle materials that can cause illness or disease. Wear protective clothing when installing or servicing a pump in an existing installation.

 **WARNING** RISK OF ELECTRICAL SHOCK. **DO NOT** use the power cord to remove or lower the pump into the basin. The cord may pull apart exposing bare wires which could cause a fire or electrical shock. Use the handle supplied with the pump for installing and removing the pump from the basin.

 **WARNING** Do not run pump dry. This pump relies on water for cooling. Running the pump dry can cause the pump to overheat and the possibility of burns to anyone that handles the pump. Running the pump dry will void the warranty.

Troubleshooting

Problem	Possible Causes	How to Correct
If the pump does not start or run	Pump is not plugged in, switch or breaker is turned off	Plug pump in or turn on switch/breaker
	Check for blown fuses or tripped circuit breakers or tripped GFCI outlets	Replace fuse, reset breaker, reset GFCI outlet
	Float switch is defective	Check and replace if necessary
	Motor thermal protector tripped	Allow pump to cool. Pump will reset automatically
	Float switch is stuck or obstructed	Remove obstruction or position pump so the float switch will operate freely
The pump starts and stops too often	Backflow of water from discharge hose/pipe	Install or replace check valve
	Float switch is defective	Replace float switch
If the pump runs but moves little or no water	Clogged discharge hose/pipe	Remove clog
	Frozen discharge hose/pipe	Allow hose/pipe to thaw
	Pump is air locked	-Drill a 3/16" hole 1"-2" above the pump discharge to prevent airlock. -If an anti-airlock hole exists, check for clogs and clean if necessary
	Low line voltage	Check wire size and increase if necessary
	Check valve is stuck in the closed position	Inspect, repair or replace if necessary
	Check valve is installed backwards	Make sure check valve is installed in the correct direction of flow
	Gate or ball valve is closed	Open valve
	Worn, damaged or clogged pump parts	Inspect for wear, damage or clog and clean or replace part if necessary
Pump does not shut off	Discharge head exceeds pump capacity	See performance chart for pump limitations
	Float switch is obstructed or stuck	Remove obstruction
	Defective Float Switch	Replace float switch

Operation

1. Plug the piggy-back plug of the float switch into a 120 volt grounded outlet. The use of a GFCI is strongly recommended. Plug the pump plug into the back of the float switch plug.
2. Test your installation by filling the basin with water. Observe the float switch through at least one complete cycle to ensure it operates freely and does not contact the sides of the basin. If necessary, adjust the tether length of the float or pump position to ensure proper operation.
3. Do not let the pump run dry. The pump depends on water for cooling and lubrication. Operating the pump without water may cause the motor to overheat or cause damage to internal parts. It may also shorten the life of your pump.
4. Your pump motor is thermally protected. It is not recommended for pumping liquids over 120°F (49°C). The thermal overload protector will automatically shut down the pump in an overheat situation. The pump will reset itself once the pump cools down. This overload is designed as a safety device and it will fail after repeated use. Normal operation is for fluids between 32°F & 120°F (0°C - 49°C).
5. Install a basin cover to prevent debris from falling into the basin and to prevent accidental injury. The basin and basin cover must use gas tight seals to prevent harmful gasses from escaping.

Maintenance

Very little maintenance is required for your pump.

1. Periodically inspect and clean the anti-airlock hole.
2. Inspect the float switches for any accumulated debris that may inhibit it from operating properly. Clean if necessary.
3. The pump has sealed, permanently lubricated bearings and requires no additional lubrication.

Performances

Height and/or piping restriction will reduce the pump output performance. It is recommended to use the same size or larger pipe as the pump discharge for optimum performance.

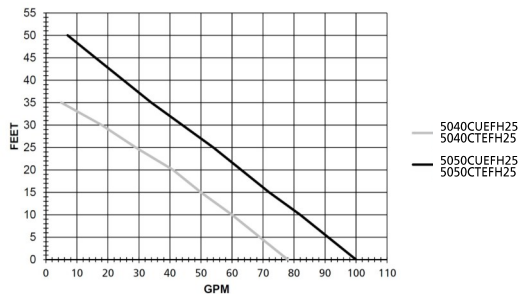

Model	Discharge Height	0' (0 m)	5' (1,5 m)	10' (3 m)	15' (4,5 m)	20' (6,1 m)	25' (7,6 m)	30' (9,1 m)	35' (10,6 m)	40' (12,2 m)	45' (13,7 m)	50' (15,2 m)
5040CUEFH25	Gallons Per Minute	78	69	60	50	41	29	18	5	-	-	-
5040CTEFH25	Liters Per Minute	295	261	227	189	155	110	68	19	-	-	-
5050CUEFH25	Gallons Per Minute	100	91	82	72	63	54	44	34	25	16	7
5050CTEFH25	Liters Per Minute	379	344	310	273	238	204	167	129	95	61	26

Specifications

Model	5040CUEFH25 5040CTEFH25	5050CUEFH25 5050CTEFH25
HP	4/10	1/2
Volts	120 volt AC	120 volt AC
Amps	7.5 Amps	12 Amps
Hz	60 Hz	60 Hz
Phase	1	1
Discharge Size	2" or 1-1/2" FNPT with adapter	2" or 1-1/2" FNPT with adapter
Max. Solids Handling	3/4" Spherical	3/4" Spherical
Max. Liquid Temperature	120°F	120°F
Float Switch Type	5040CUEFH25 - None 5040CTEFH25 - Tethered	5050CUEFH25 - None 5050CTEFH25 - Tethered
Switch on Level* (Factory Set)	5040CTEFH25 - 16"	5050CTEFH25 - 16"
Switch off Level (Factory Set)	5040CTEFH25 - 6"	5050CTEFH25 - 6"
Cord Length	25'	25'
Pump Housing Construction	Stainless Steel	Stainless Steel
Pump Base Construction	Cast Iron	Cast Iron
Impeller	Stainless Steel Vortex	Stainless Steel Vortex
Motor Shaft	Stainless Steel	Stainless Steel
Shaft Seal	Carbon/Ceramic/Stainless Steel	Carbon/Ceramic/Stainless Steel
Shut off head	36 Feet	51 Feet

Dimensions

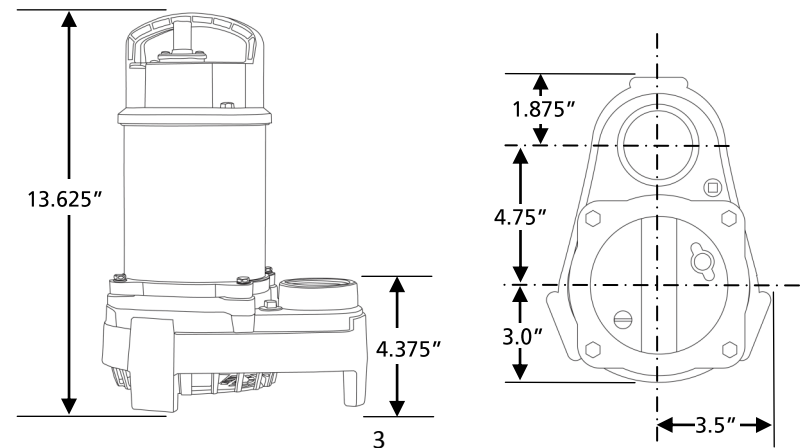

Installation

Sump Applications

1. Place the pump in the basin on a solid level surface. Do not place the pump directly in mud, sand, silt or gravel as these materials can clog or cause damage to the pump.
2. Position the pump in the basin ensuring that there is at least 1" of clearance from the float switch to the side of the basin and is free from any possible obstructions. The pump should be positioned so the float switch is away from the incoming water.
3. Install discharge piping according to local and state codes. The pipe size should be the same size as the pump discharge.
4. Drill a 3/16" weep hole (also called an anti-airlock hole) in the discharge pipe approximately 1"-2" above the pump discharge. The hole must be below the check valve and below the basin cover. A water stream will be visible from this hole when the pump is running. This hole should be cleaned periodically.
5. Install a check valve/union combination above the basin cover to allow easy removal of the pump for cleaning or repair. It is also highly recommended to install a gate or ball valve above the check valve to prevent backflow of water when servicing the pump.
6. Connect the remaining discharge pipe using the shortest length of pipe and fewest number of turns as possible.
7. Secure the power cord(s) to the discharge pipe using cable clamps or zip ties to prevent possible entanglement with the float switch.

Installation

Effluent Applications

1. Place the pump in the basin on a solid level surface. Use bricks or blocks to raise the pump off of the bottom. Do not place the pump directly in mud, sand, silt or gravel as these materials can clog or cause damage to the pump.
2. Position the pump in the basin ensuring that there is at least 1" of clearance from the float switches to the side of the basin and is free from any possible obstructions. The pump should be positioned so the float switch is away from the incoming water.
3. Install discharge piping according to local and state codes. The pipe size should be the same size as the pump discharge. Do not reduce the pipe size below 2". In some installations, it may be necessary to increase the pipe size to reduce friction losses.
4. Drill a 3/16" weep hole (also called an anti-airlock hole) in the discharge pipe approximately 1"-2" above the pump discharge. The hole must be below the check valve and below the basin cover. A water stream will be visible from this hole when the pump is running. This hole should be cleaned periodically.
5. Install a check valve/union combination above the basin cover to allow easy removal of the pump for cleaning or repair. It is also highly recommended to install a gate or ball valve above the check valve to prevent backflow of sewage when servicing the pump.

Installation

Effluent Applications

6. Connect the remaining discharge pipe using the shortest length of pipe and fewest number of turns as possible.
7. If using float switch(es) other than what is included with the pump, attach them to the discharge pipe at this time. Adjust the on/off levels per your requirements.
8. Secure the power cord(s) to the discharge pipe using cable clamps or zip ties to prevent possible entanglement with the float switch.
9. All installations must use a basin cover to prevent debris from entering the basin.

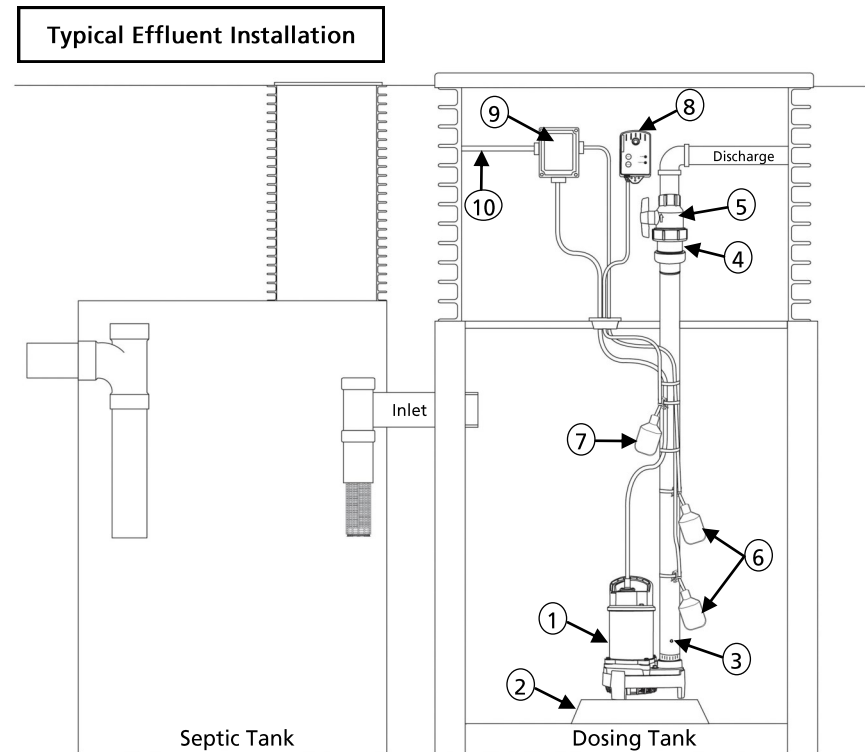

1. Pump must be positioned so the float switch will operate freely without contacting the sides of the basin.
2. Use blocks or bricks to raise the pump off the bottom of the basin.
3. 3/16" Anti-airlock hole.
4. Check valve / union combination
5. Gate / Ball valve
6. On/Off float switches
7. High water alarm float switch
8. High water alarm
9. Watertight junction box
10. Electrical supply must be in accordance with the National Electric Code (NEC) and/or other applicable codes